

PLEGA ORIGAMI

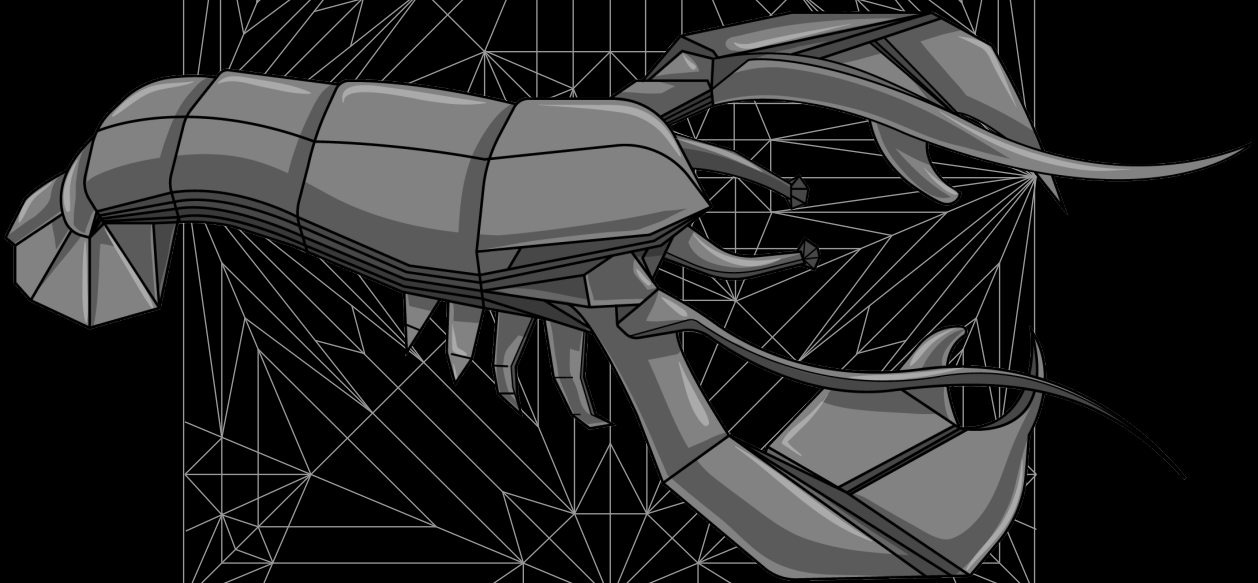

HOMARD



Livret N°1

Homard de Bretagne 1.5

Gilles Adrien Petit

www.Plegaorigami.com

youtube.com/plegaorigami

facebook.com/plegaorigami



Papier recommandé :

Papier de soie

Taille recommandé :

50x50 / 2 = 50x25 base rectangle

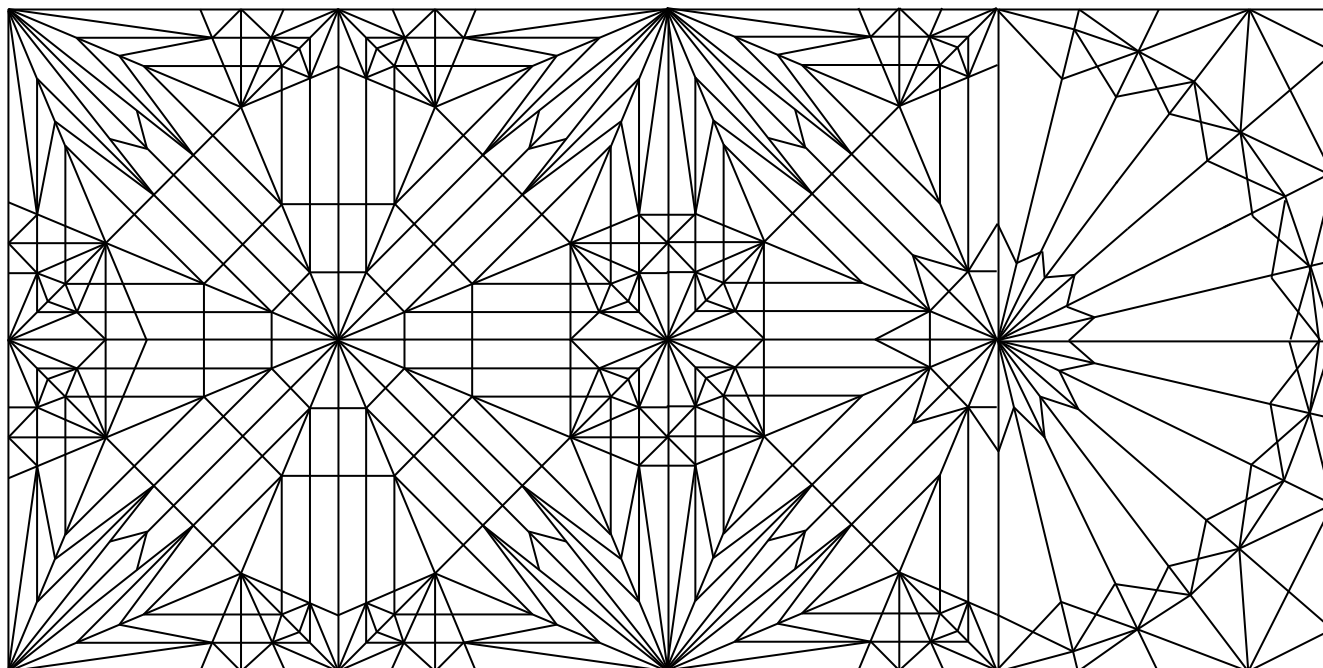
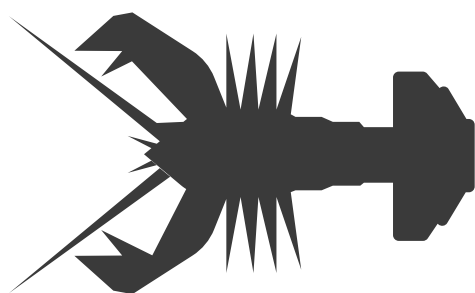
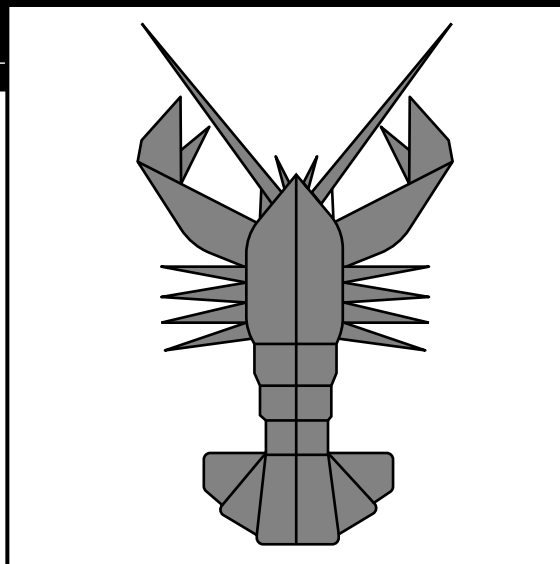

HOMARD : ★★☆☆★

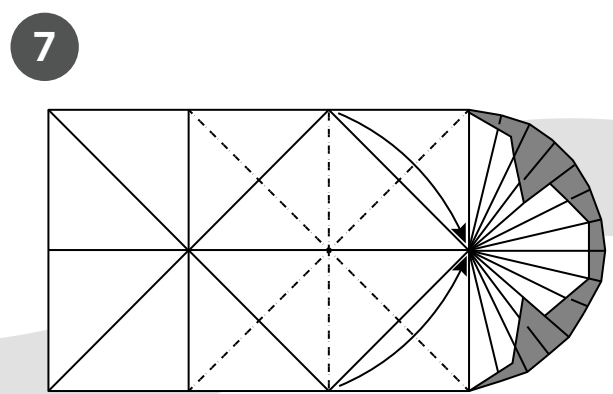
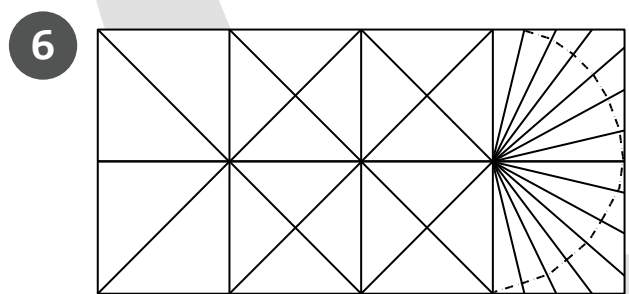
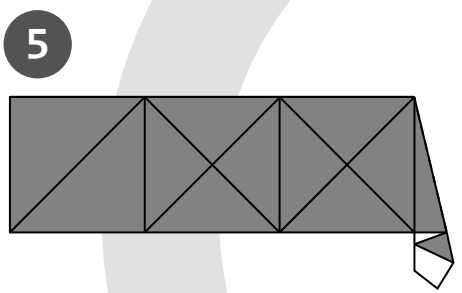
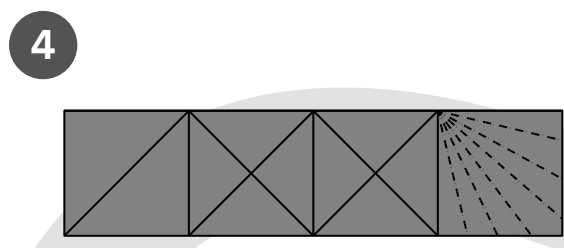
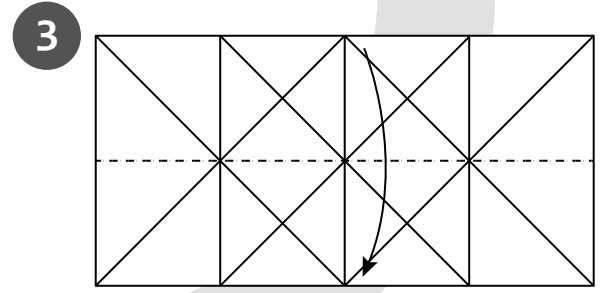
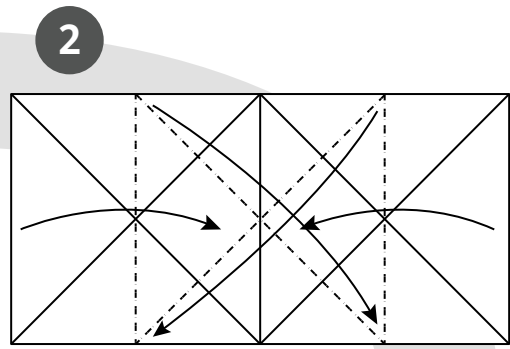
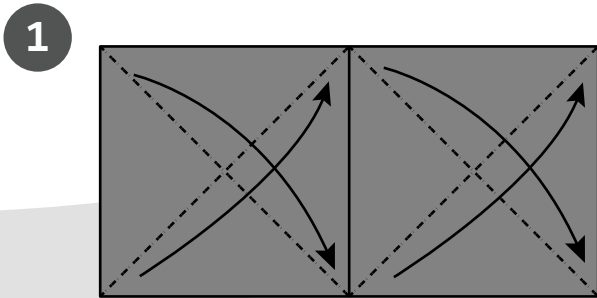
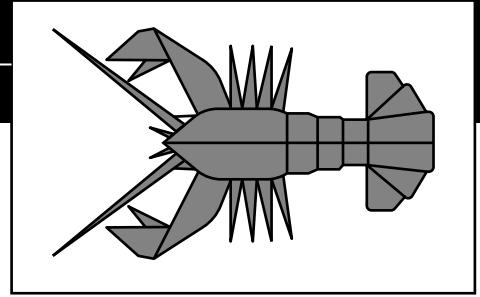

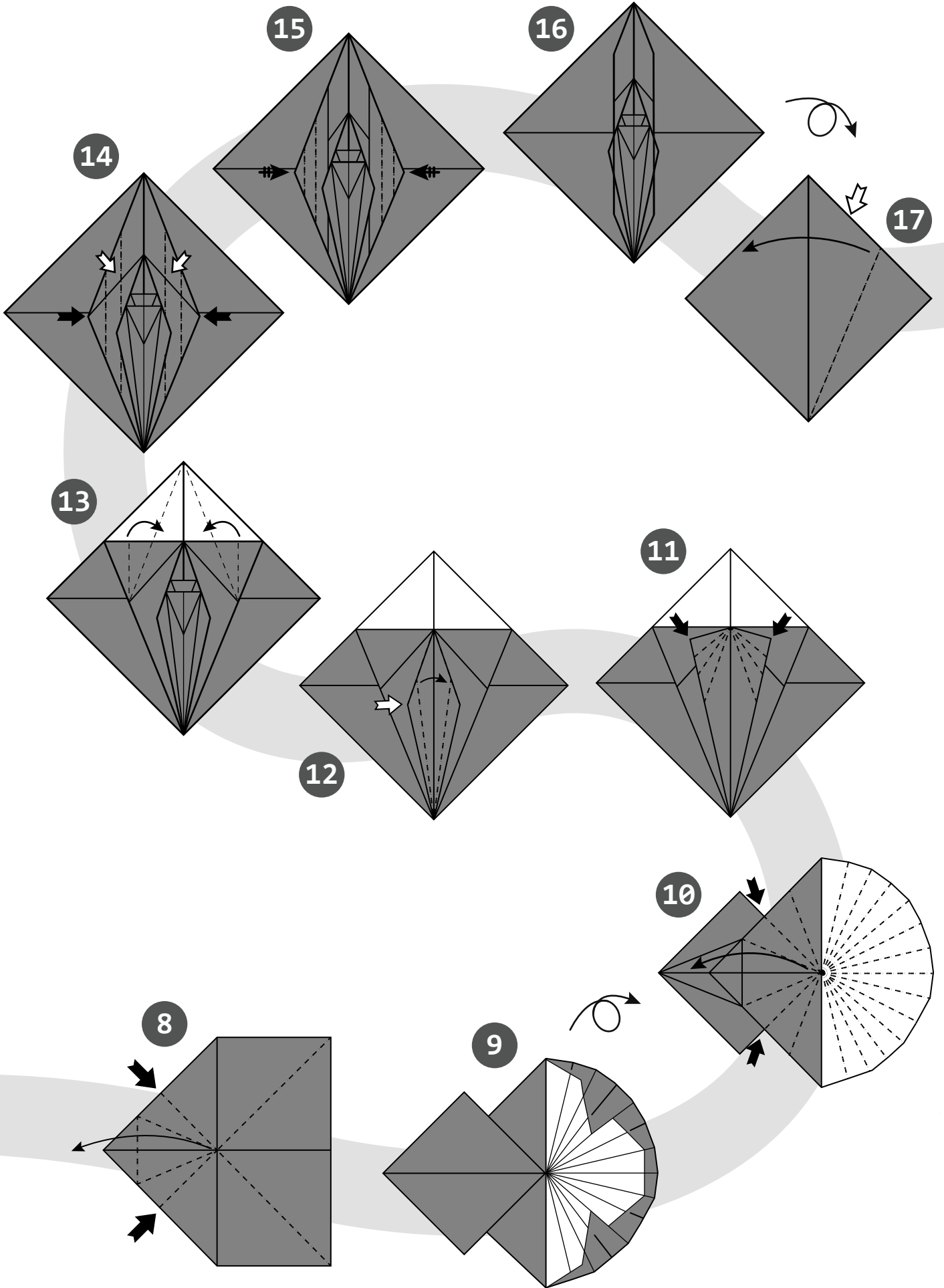

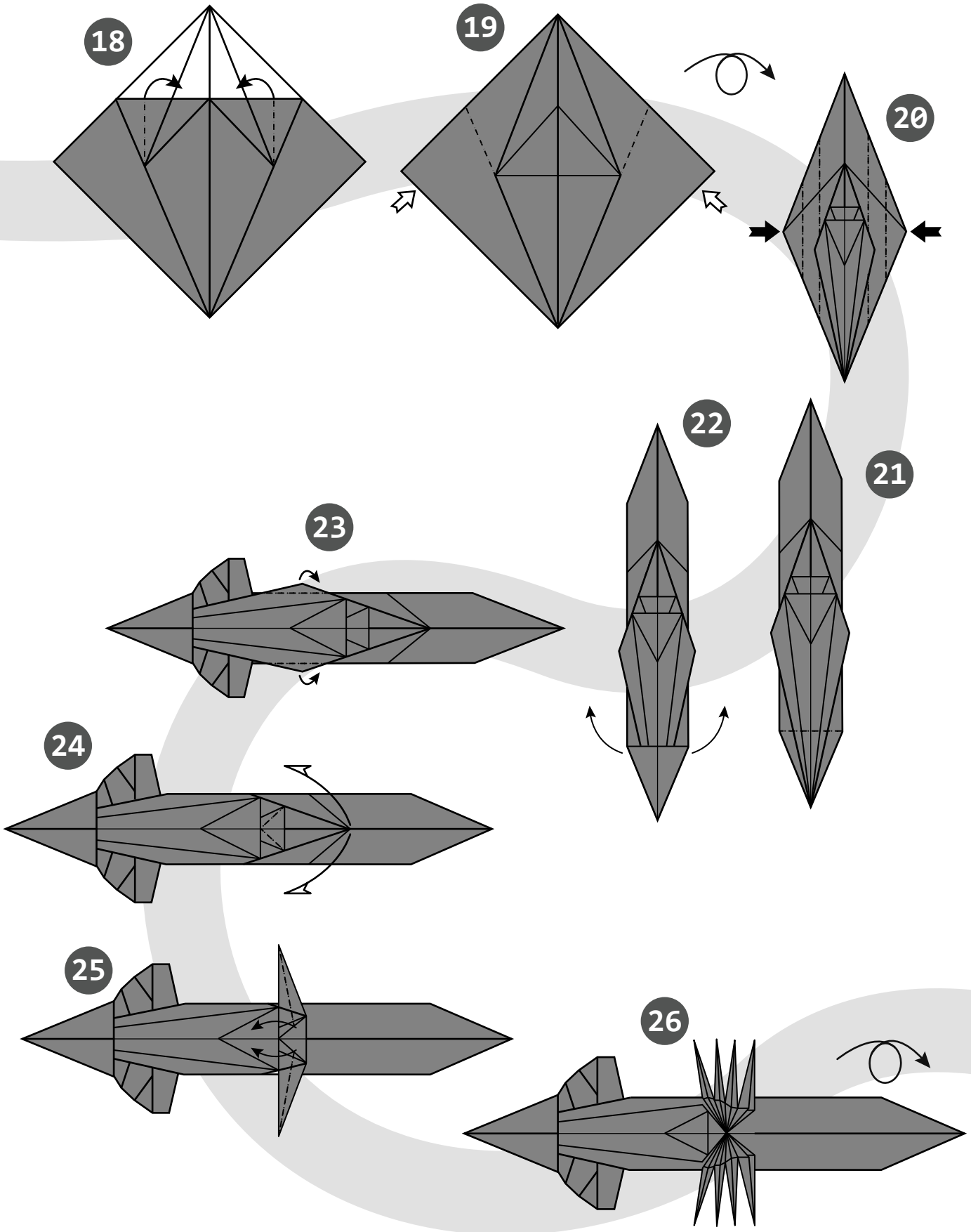

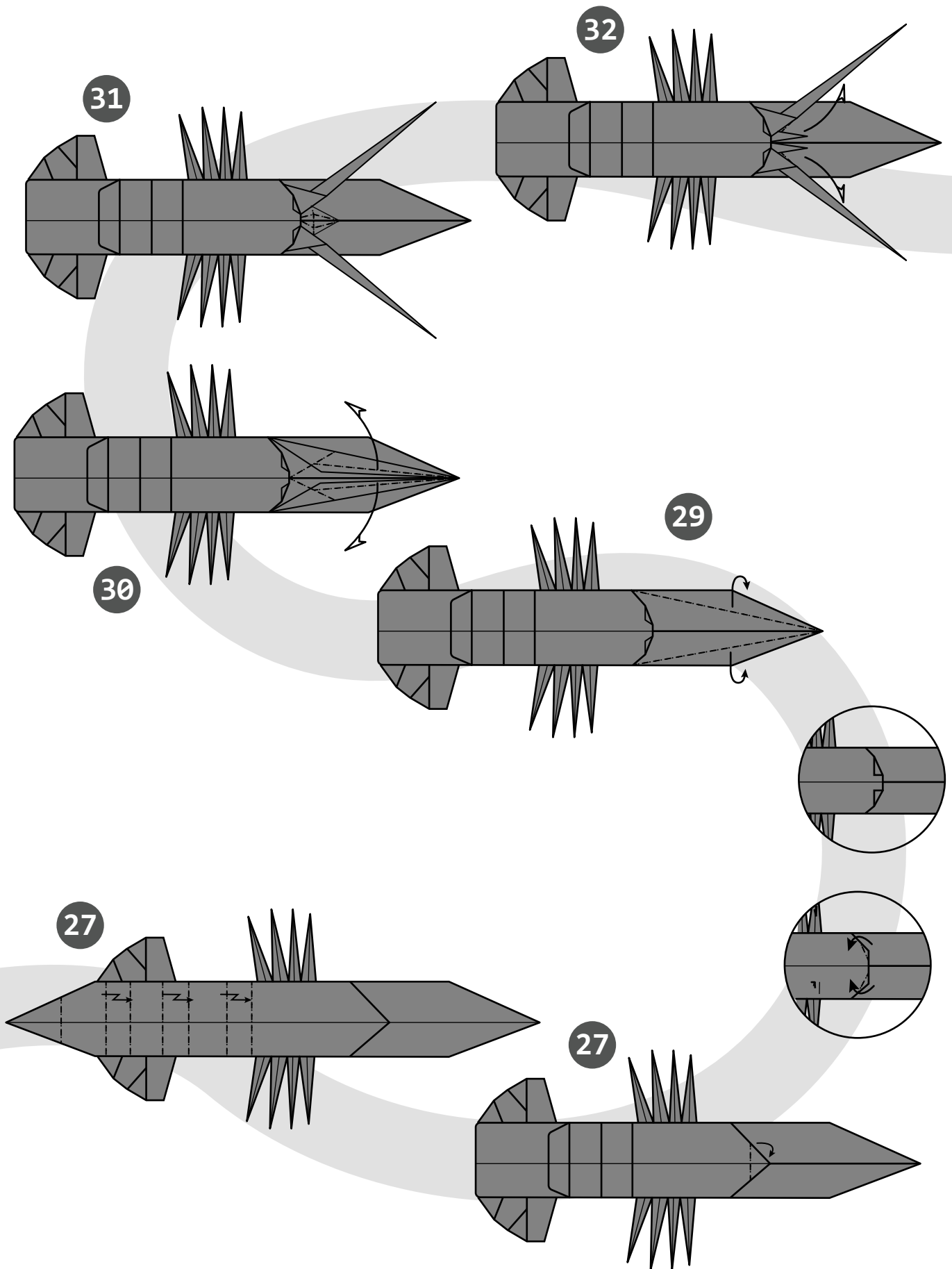

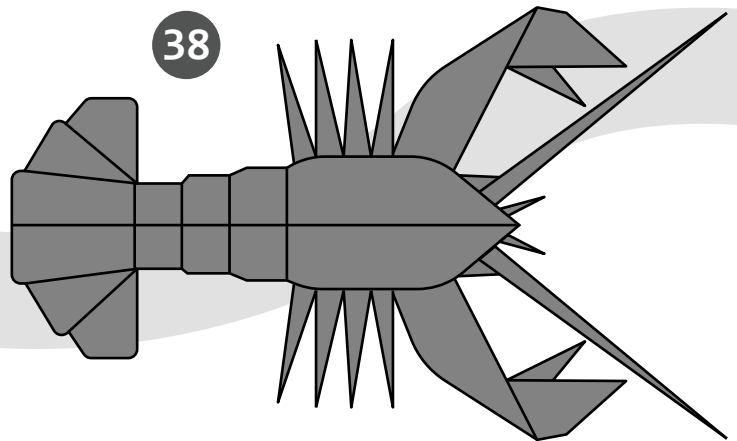
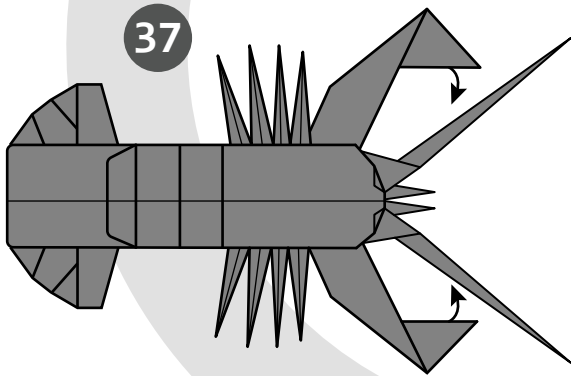
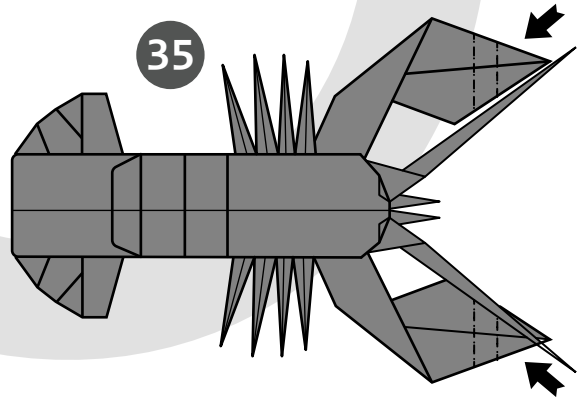
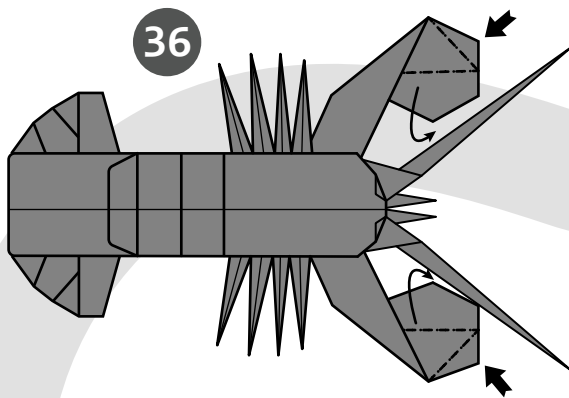
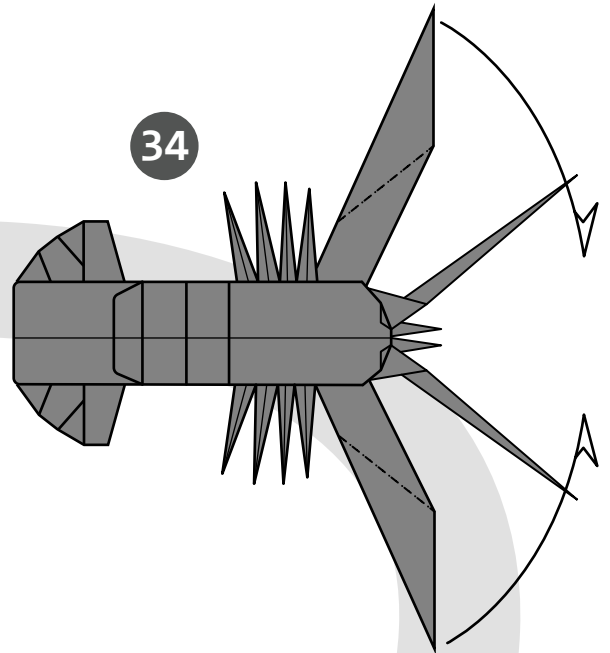
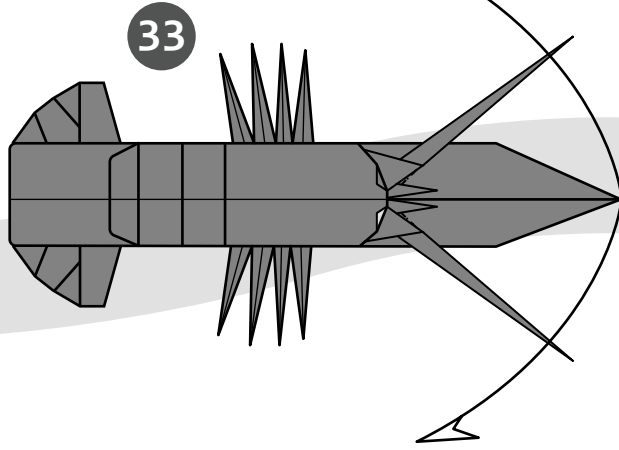

Explications des symboles

PLI VALLÉ - - - - -

PLI MONTAGNE - - - - -

PLIER DEVANT 

PLIER DERRIERE 

REPLI 

PLIER ET DEPLIER 

INSERER ; GLISSER DANS 

TOURNER LE MODELE 

GUIDER LA POINTE ; LE FUILLET 

**REPETER L'OPERATION
AUTANT DE FOIS QU'IL Y A DE BARRES** 

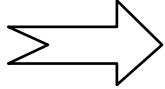
DEPLIER 

ENFONCER ; APUYER 

VUE AGRANDIE 

MAINTENIR CE POINT 

MODELER ; DONNER DU VOLUME 

SOUFFLER ; GONFLER 

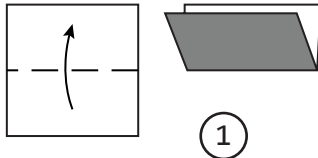
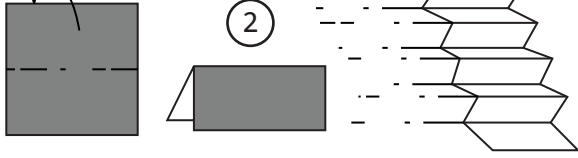
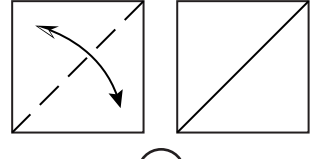
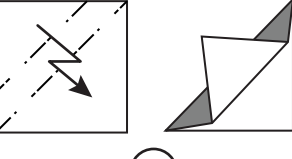
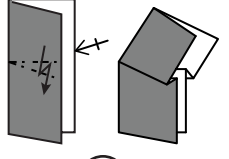
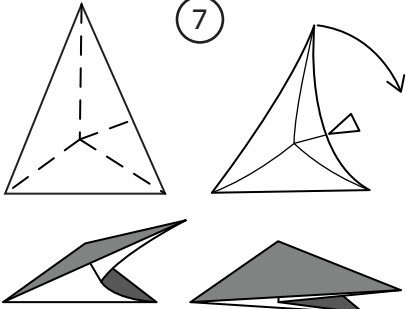
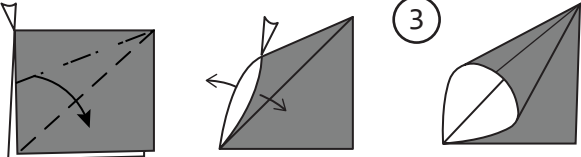
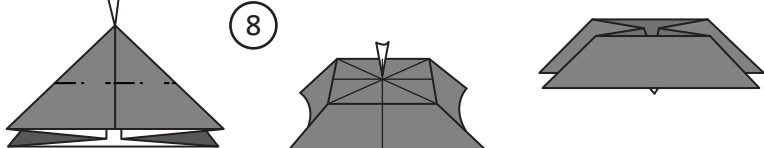
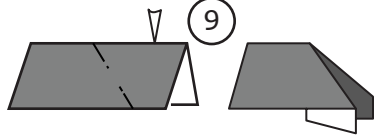
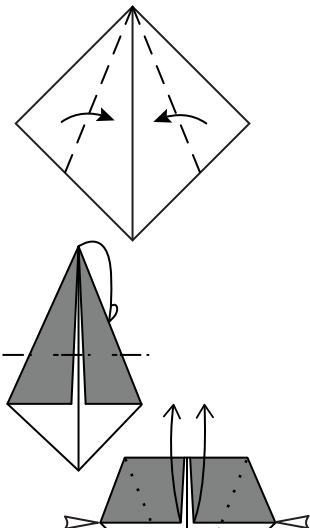
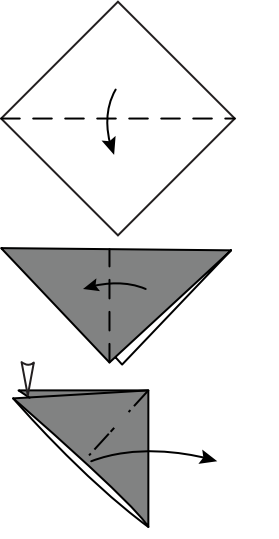
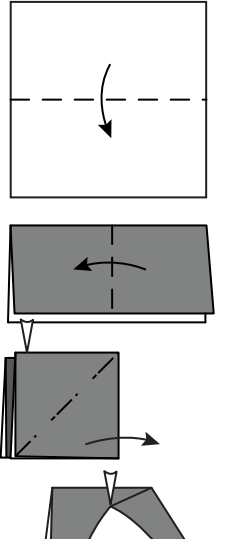
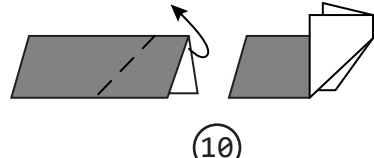
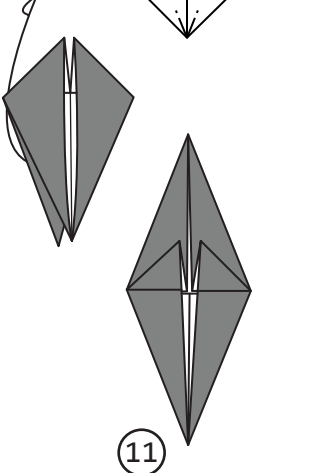
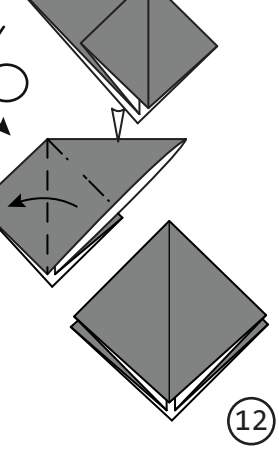
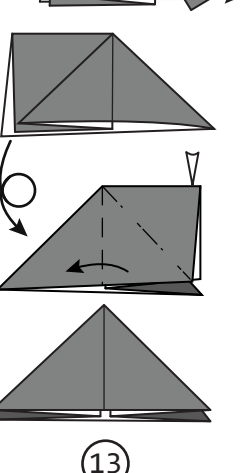
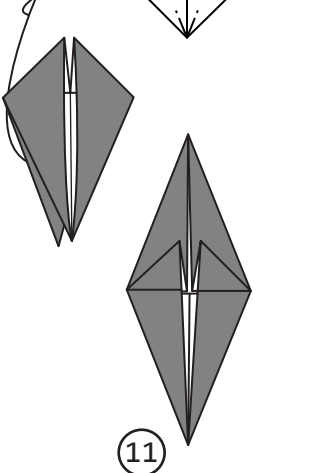
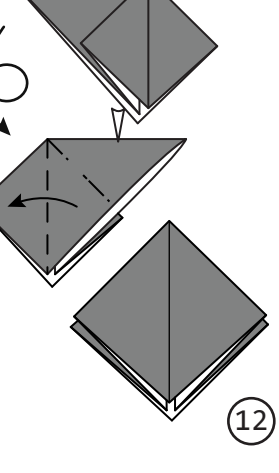
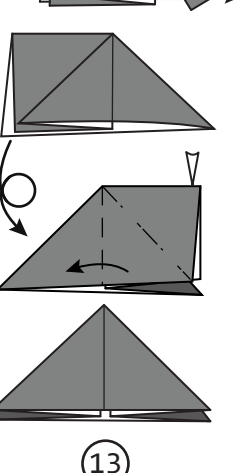

<p>1) PLI VALLÉE 2) PLI MONTAGNE 3) PLIER ; DEPLIER 4) REPLI 5) AUTRE TYPE DE REPLI 6) PLI APLATI 7) OREILLE DE LAPIN 8) PLI INVERSE INTERIEUR 9) PLI INVERSE INTERIEUR 10) PLI INVERSE EXTERIEUR</p>	 <p>1</p>	 <p>2</p>	
	 <p>3</p>	 <p>4</p>	 <p>5</p>
 <p>7</p>	 <p>3</p>	 <p>8</p>	
 <p>9</p>	 <p>11</p>	 <p>12</p>	 <p>13</p>
 <p>10</p>	 <p>11</p>	 <p>12</p>	 <p>13</p>
<p>11) BASE DU POISSON 12) BASE PRELIMINAIRE 13) BASE DE LA BOMBE A EAU</p>	 <p>11</p>	 <p>12</p>	 <p>13</p>

Tester les plis pour vous familiariser avec les symboles.