

PLEGA
ORIGAMI

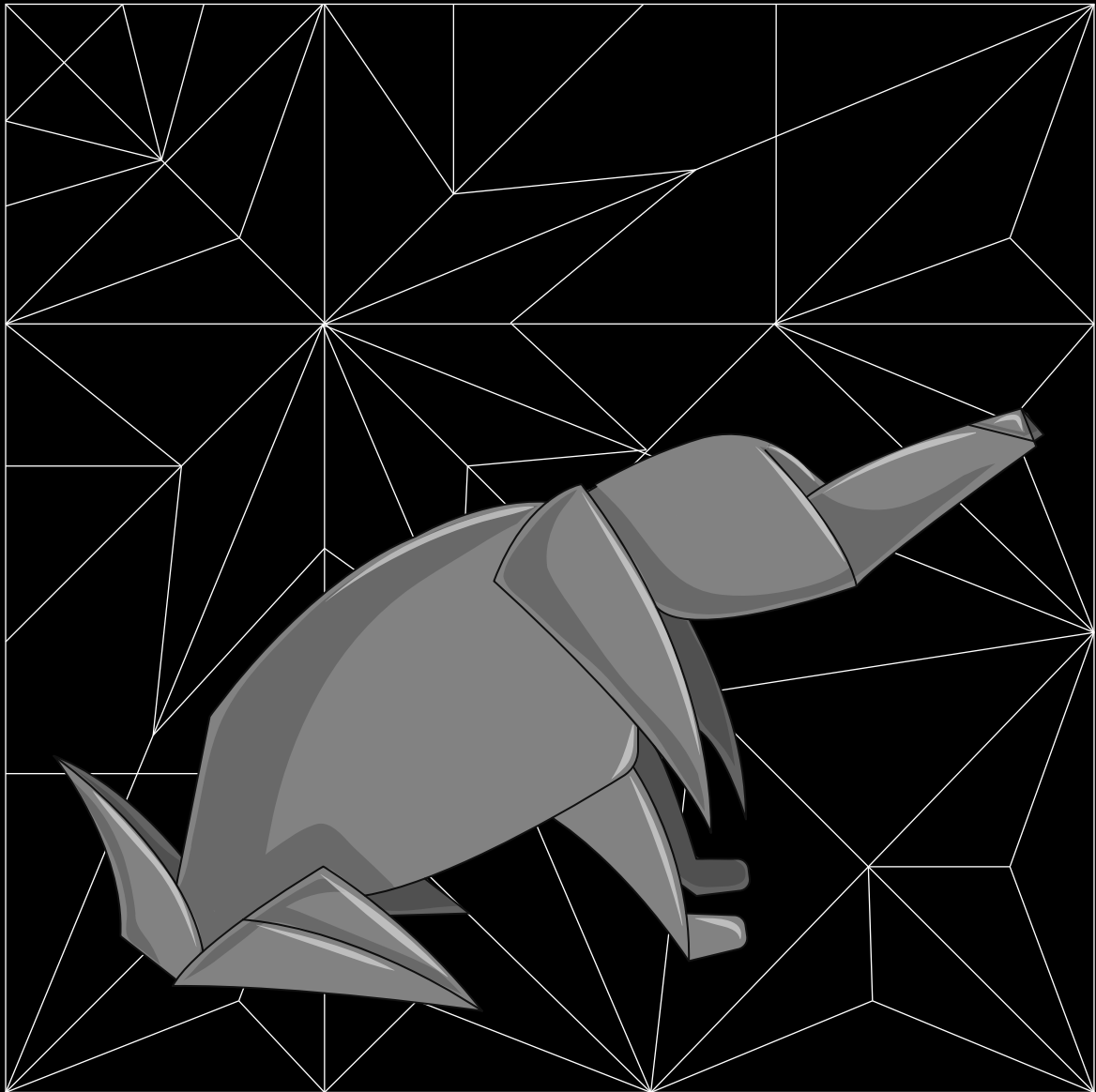

CHIEN



Livret N°4

Chien : ★★★

Gilles Adrien Petit

www.Plegaorigami.com

youtube.com/plegaorigami

facebook.com/plegaorigami



Papier recommandé :

Papier normal

Taille recommandé :

20x20 cm

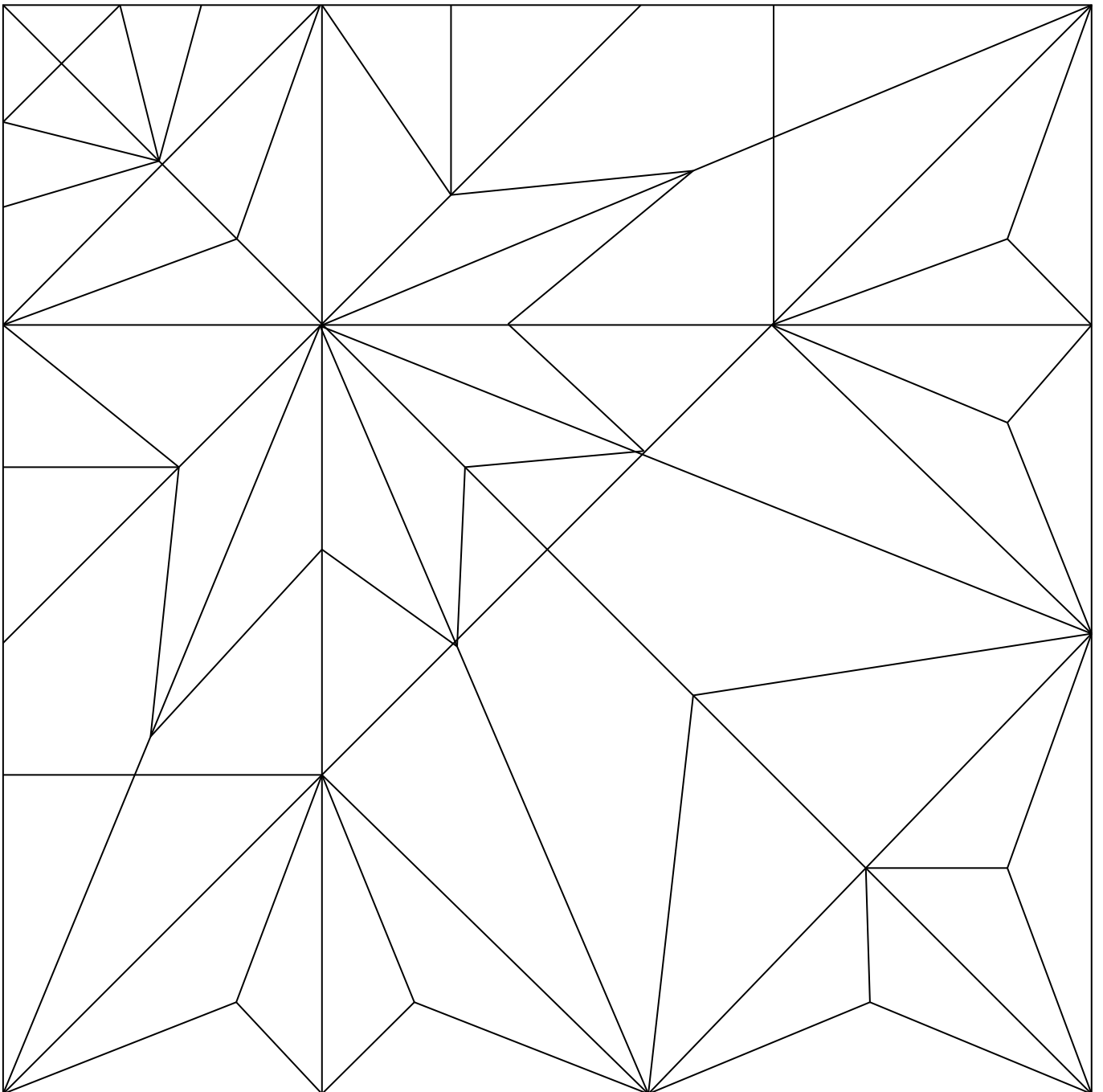
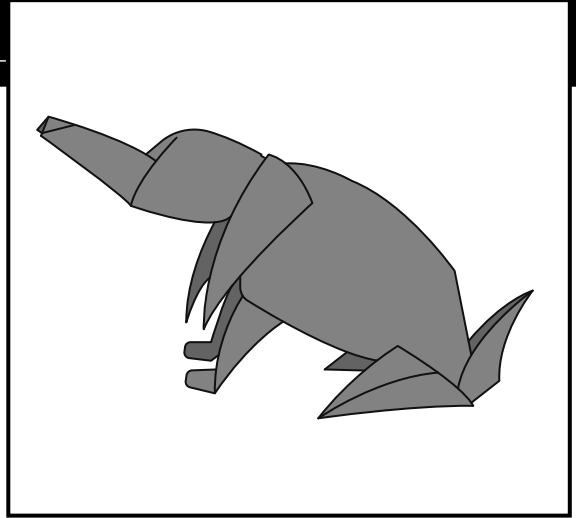

Explications des symboles

PLI VALLÉ..... - - - - -

PLI MONTAGNE..... - - - - -

PLIER DEVANT..... 

PLIER DERRIERE..... 

REPLI..... 

PLIER ET DEPLIER..... 

INSERER ; GLISSER DANS..... 

TOURNER LE MODELE..... 

GUIDER LA POINTE ; LE FUILLET..... 

**REPETER L'OPERATION
AUTANT DE FOIS QU'IL Y A DE BARRES**..... 

DEPLIER..... 

ENFONCER ; APUYER..... 

VUE AGRANDIE..... 

MAINTENIR CE POINT..... 

MODELER ; DONNER DU VOLUME..... 

SOUFFLER : GONFLER..... 



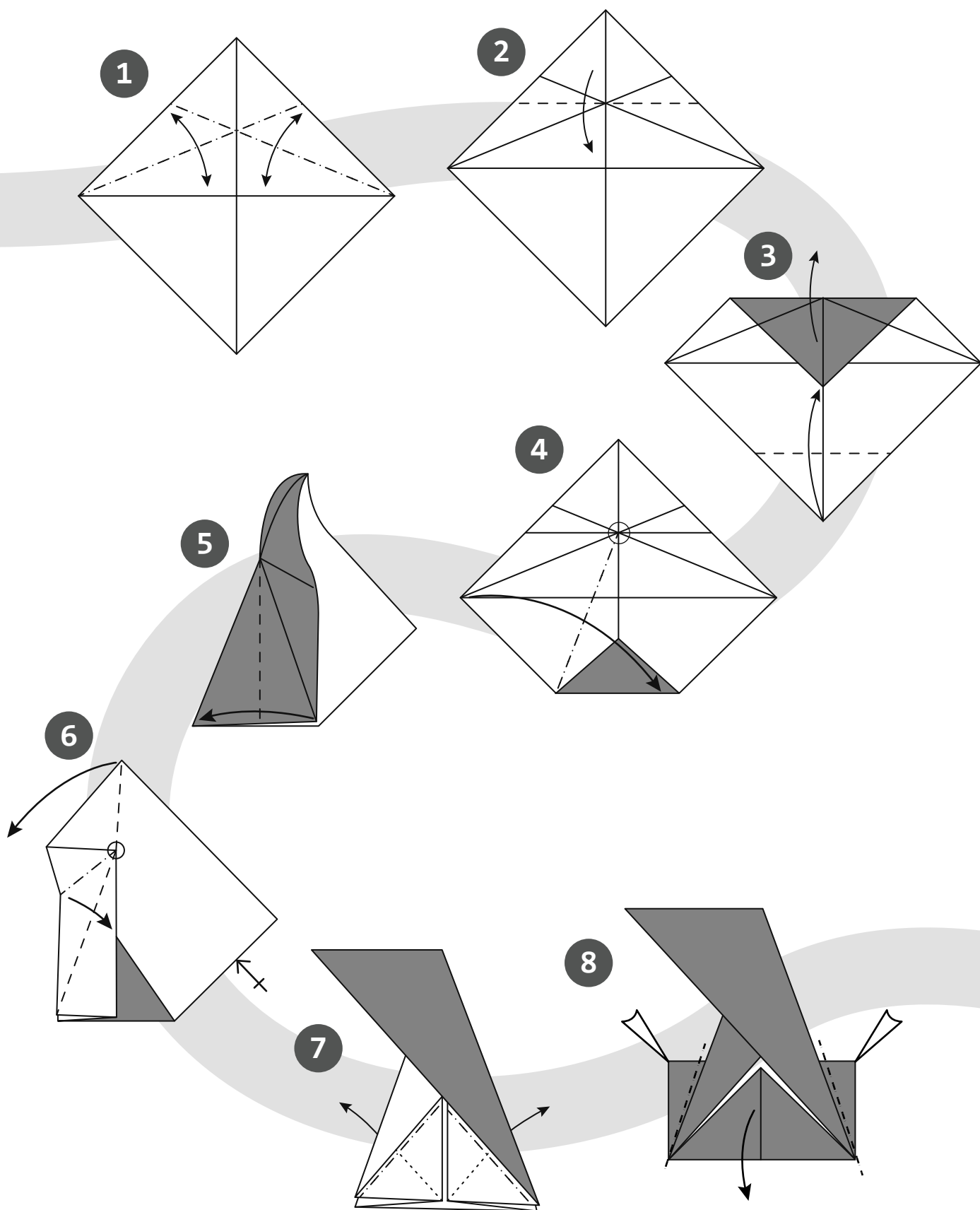
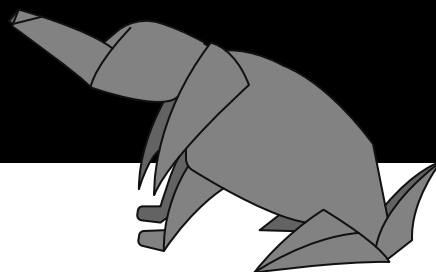

CHIEN :

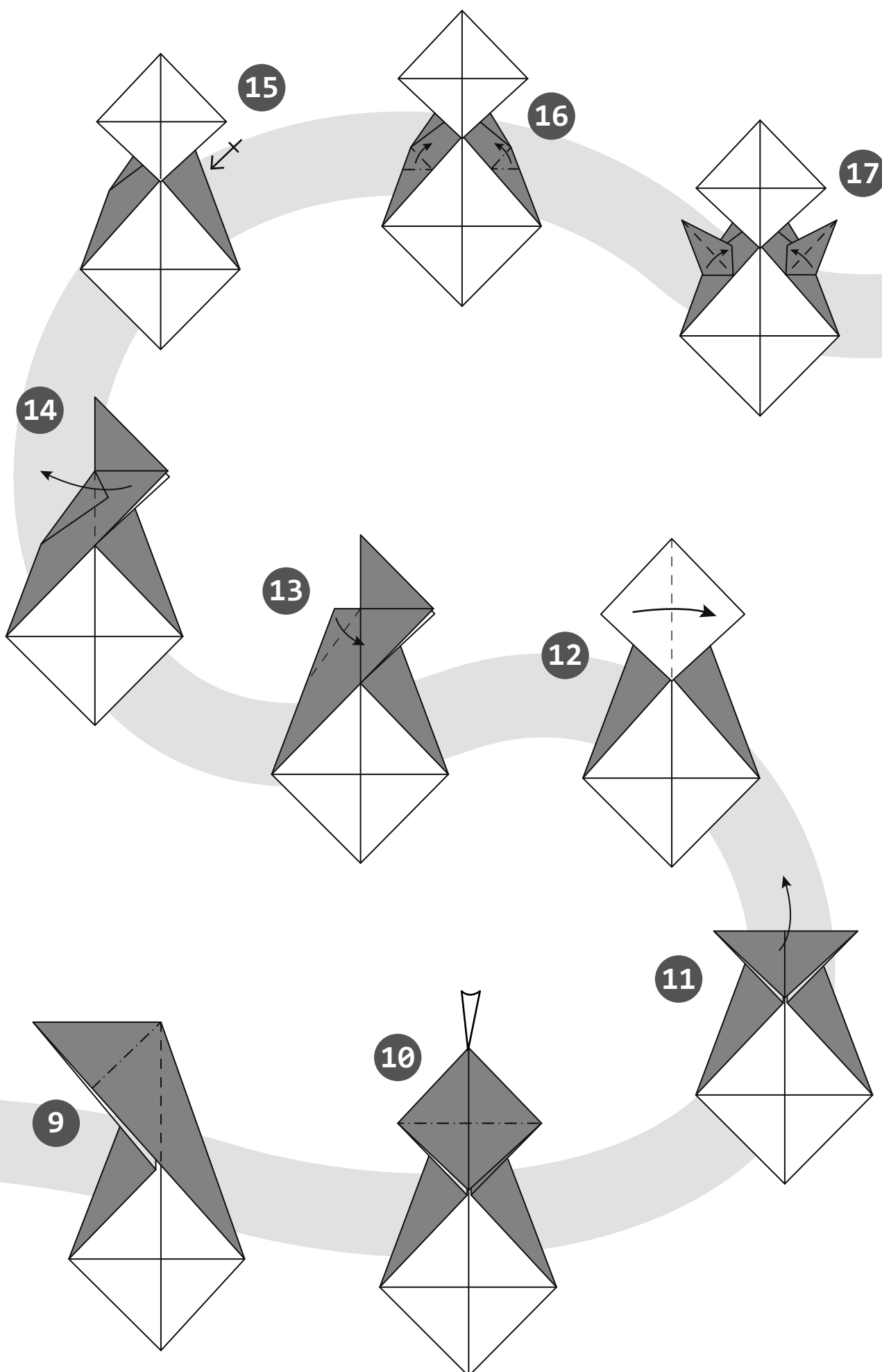

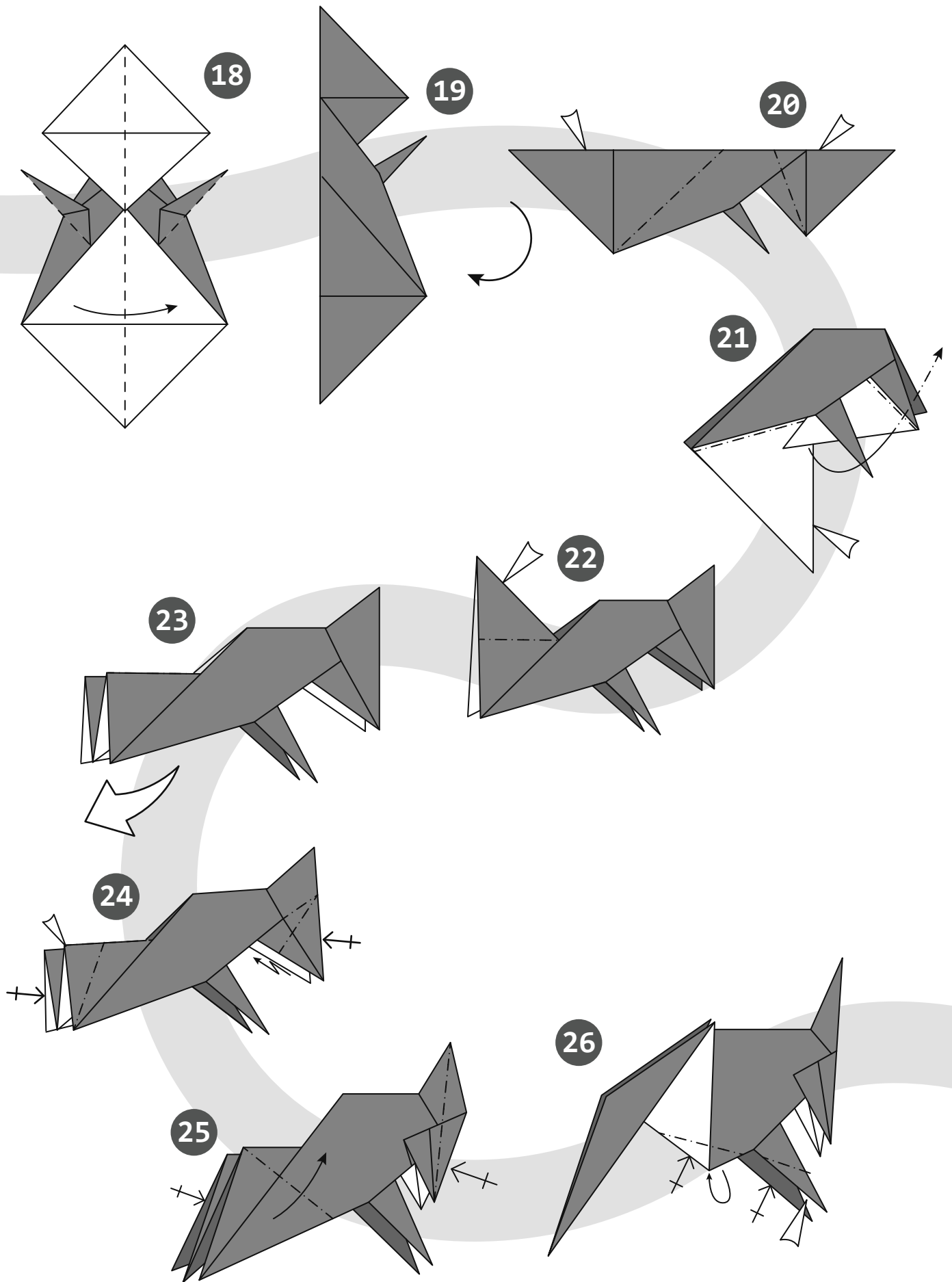

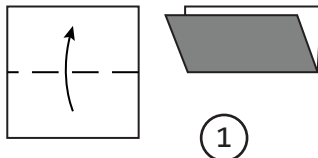
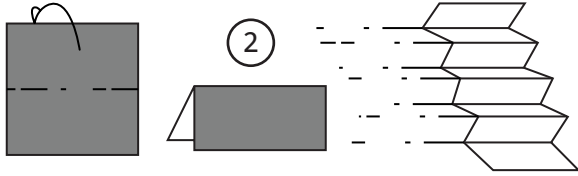
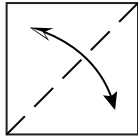
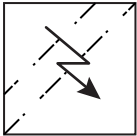
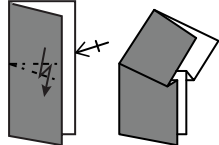
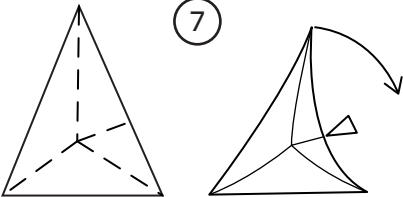
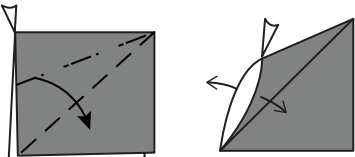

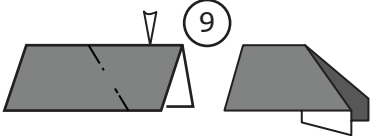
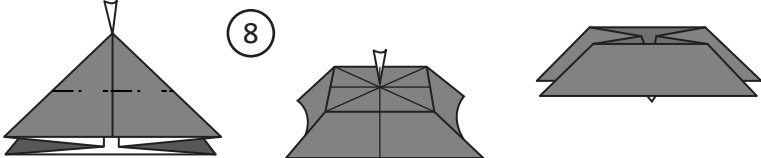
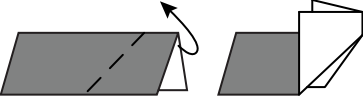
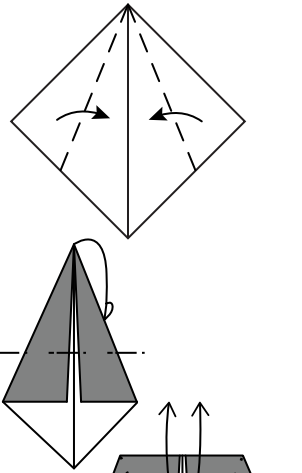
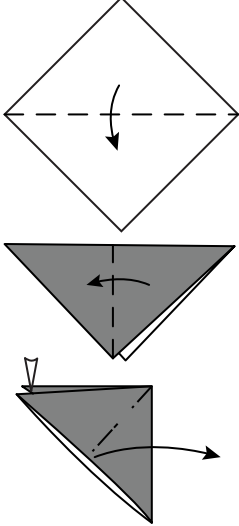
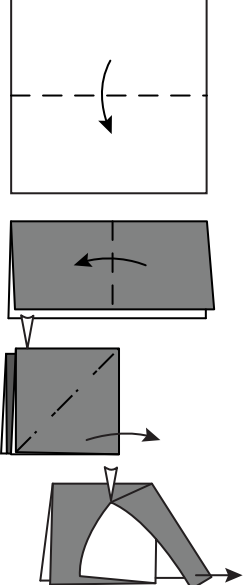
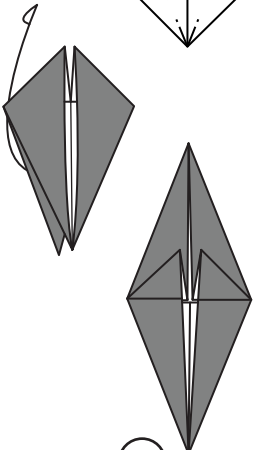
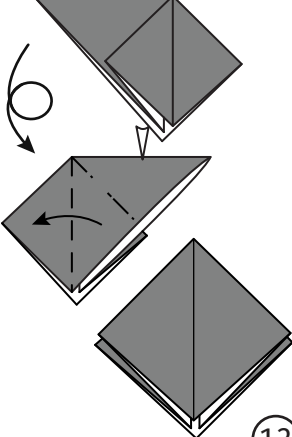
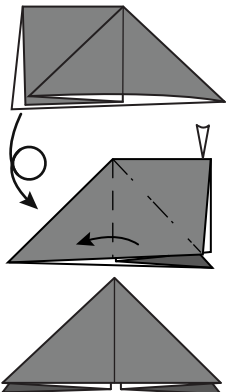
<p>1) PLI VALLÉE 2) PLI MONTAGNE 3) PLIER ; DEPLIER 4) REPLI 5) AUTRE TYPE DE REPLI 6) PLI APLATI 7) OREILLE DE LAPIN 8) PLI INVERSE INTERIEUR 9) PLI INVERSE INTERIEUR 10) PLI INVERSE EXTERIEUR</p>	 <p>1</p>	 <p>2</p>	
	 <p>3</p>	 <p>4</p>	 <p>5</p>
 <p>7</p>	 <p>3</p>	 <p>8</p>	
 <p>9</p>	 <p>8</p>		
 <p>10</p>	 <p>11</p>	 <p>12</p>	 <p>13</p>
<p>11) BASE DU POISSON 12) BASE PRELIMINAIRE 13) BASE DE LA BOMBE A EAU</p>	 <p>11</p>	 <p>12</p>	 <p>13</p>

Tester les plis pour vous familiariser avec les symboles.

32

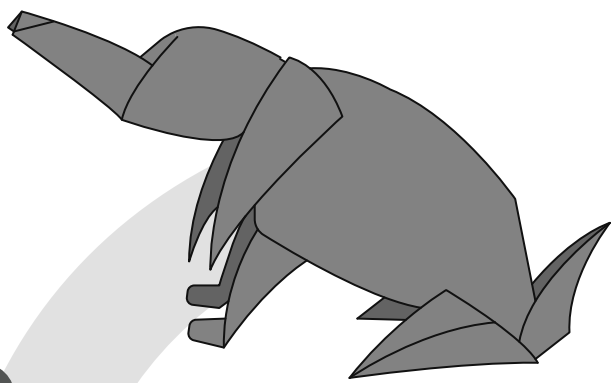

31

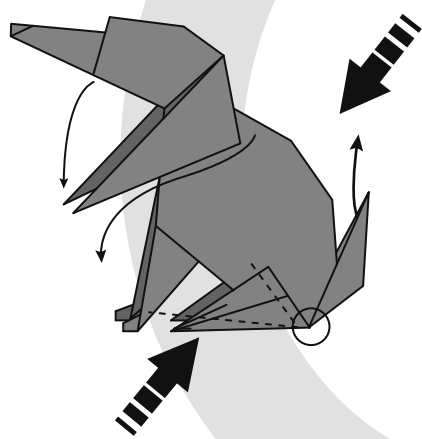

30

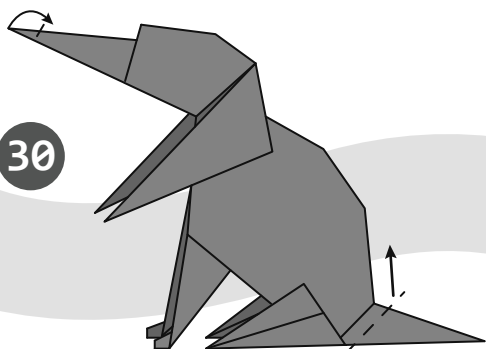

29

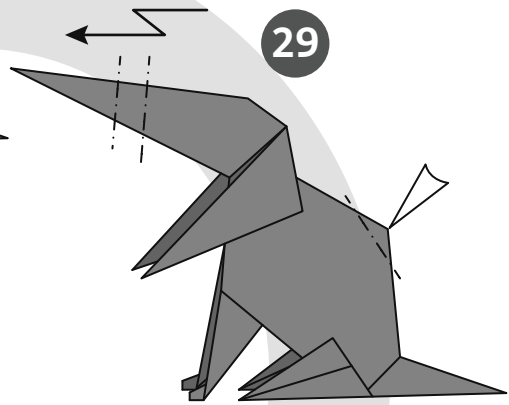

27

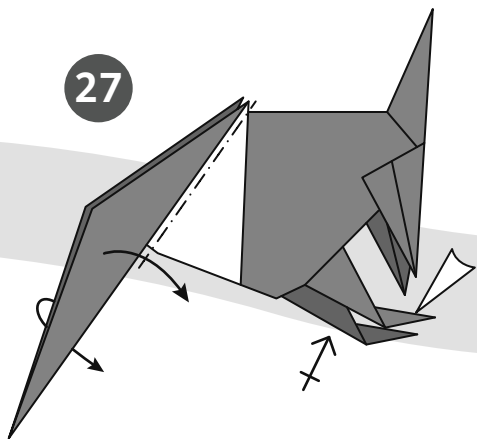

28

